

# S303 & S304 Dust Monitors



**S303 - Process Monitor**  
**S304 - Emissions Monitor**  
**Software and Networking**



# S303 Process Monitor & S304 Emissions Monitor

- Easy start-up and commissioning
- Rugged design for harsh industrial conditions
- Proven technology
- Accurate dust measurement
- Extremely wide measurement range
- Detection limit of 0,01 mg/m<sup>3</sup>
- Ex model is suitable for Zone 20, 21 and 22 inside and Zone 21 and 22 outside the duct
- Multipoint calibration
- Normalized measurement response
- Flow speed compensation (optional)
- Automatic Zero and Span check (S304)
- 4-20mA, RS485, USB, two status relays and wireless option
- Local display, user interface and 3 color status LEDs

● Alarm   
 ● Alert   
 ● Normal

Based on Sintrol's proven **Inductive Electrification Technology**, the S300 series has a detection limit of 0,01 mg/m<sup>3</sup>, while maintaining its globally recognized reliability and robustness. Available features allow the S300 series to be used for a wide variety of applications such as stack-, process- and filter house monitoring. It can be installed into process applications like baghouse, cyclone, dryer or other dust collection systems to monitor particulate emissions as well as filter performance.

The S300 series is also often used for process control in applications where the dust levels need to follow designated limits. The on-board relays of the S300 series can be used as a dust level ALERT / ALARM signal. The mA output and the RS485 interface makes the instrument ideal for trend monitoring applications. Very short response time is a typical characteristic of Sintrol's dust monitors, enabling early detection of malfunctions in the dust removal process and prevention of expensive product loss to the environment.

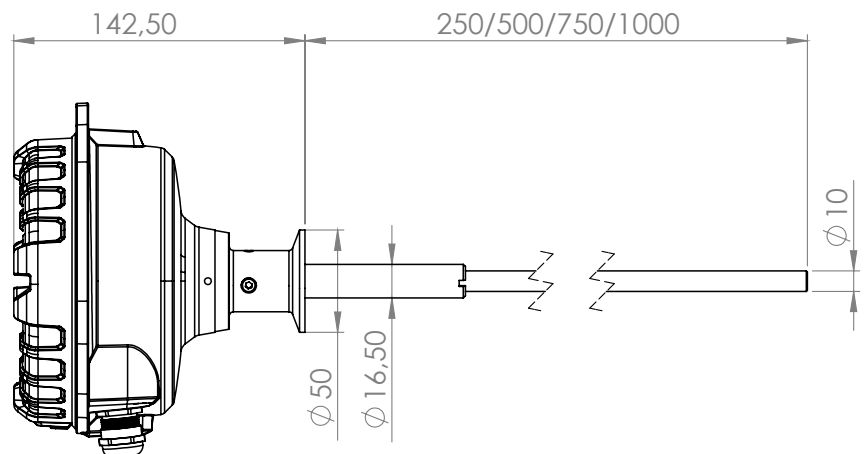
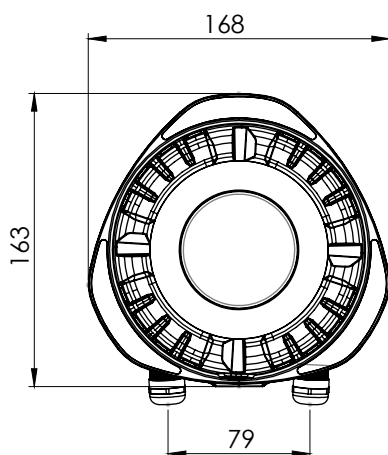
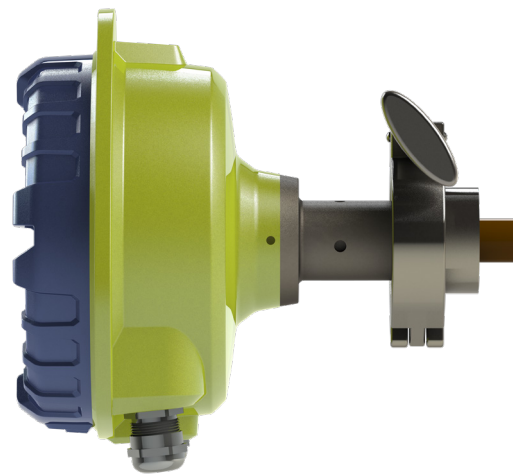

## Features

X Standard, ○ Optional

	S303	S304
Rugged IP66 rated Aluminum pressure casted enclosure	X	X
Quick clamp process connection for easy installation	X	X
Green, yellow and red LED for status indication	X	X
Auto Setup function for efficient commissioning	X	X
Two dry contact relays to indicate dust alert and dust alarm	X	X
The instrument can be powered with 24 VDC or 100 to 240 VAC	X	X
USB interface for convenient connection during commissioning	X	X
DustTool PC-software for parametrization and setup	X	X
Normalized during production to ensure identical instruments and quality	X	X
Linearized during production to standard test dust (Arizona Road Dust)	X	X
RS485 to communicate with Modbus RTU or Sintrol protocol	X	X
Bright green illuminated 4- digit display and buttons for local setup and status	X	X
Isolated and active mA-output, with NAMUR NE 43 compliant alarms	X	X
Zero and Span check with automatic drift compensation		X
Calibration possibility to read directly mg/m <sup>3</sup>		X
Flow speed compensation by the mA-output of a third party measurement device		X
Wireless Network capability to avoid cabling cost and extensive installation	○	○

## Inductive Electrification Technology



The measurement of Sintrol dust monitors is based on particles interacting with an isolated probe mounted into a duct or stack. When moving particles pass nearby or hit the probe, a signal is induced. This signal is then processed through a series of Sintrol's advanced algorithms to filter out the noise and provides the most accurate dust measurement. Classic **triboelectric technology** is based on the DC signal, which is caused by particles making contact with the sensor to transfer charges. **Inductive Electrification Technology** is based on the Triboelectric AC signal and it minimizes the influence of sensor contamination, temperature drift and velocity changes. By using Inductive Electrification Technology, it is possible to reach a detection limit as low as 0.01 mg/m<sup>3</sup>.

## Sintrol's Unique Auto Setup Function

The **Auto Setup** function is a unique Sintrol Dust Monitor feature which allows for a simple, user friendly setup. During the Auto Setup procedure, which is done in normal process conditions, the dust monitor will automatically adapt to the process conditions and set the measuring range and alarms accordingly. At normal conditions the instrument will show green light and the mA output is set to 5% of range.

In case the measuring point is before the filtration system, the Auto Setup baseline could be several g/m<sup>3</sup> and after the filtration system the Auto Setup baseline could be only a few mg/m<sup>3</sup>. In both cases, no manual range setup is required.

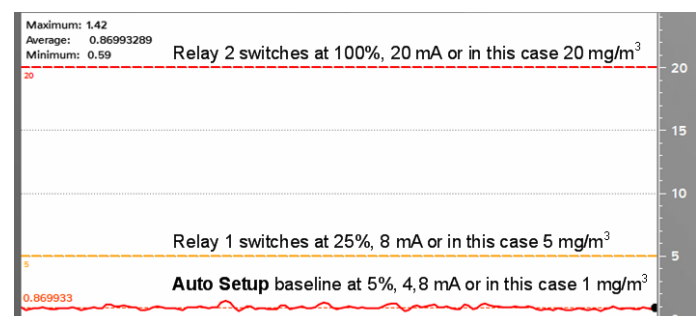

## Proven Technology

Since 1993, Sintrol has become a globally recognized dust monitoring supplier with over 17 000 installations in more than 50 countries. The measuring principle has evolved into a proven standard for dust monitoring needs.

Extensive tests of S300 have been carried out in Finland and Germany. The results showed excellent linearity over various dust types. The graph below illustrates the mA output on standard test dust ISO 12103 medium (Arizona Road Dust).

Temperature tests showed close to no impact over the whole temperature range.

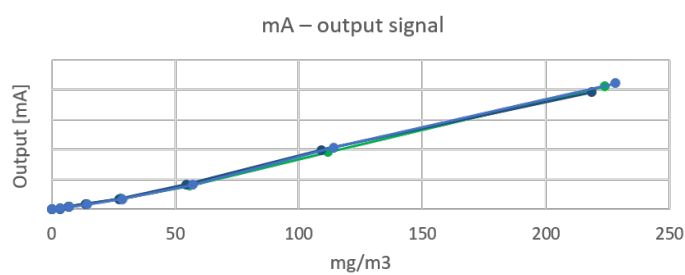

## Local Display and User Interface

The S303 and S304 are equipped with a local user interface for setup and adjusting the instrument. The operator can see the actual measurement values on the 4-digit 7-segment display in mA, % or mg/m<sup>3</sup>. With the 4-button interface the operator can navigate and change the most important operating parameters.

Next to the display, is a button to start the Auto Setup procedure.

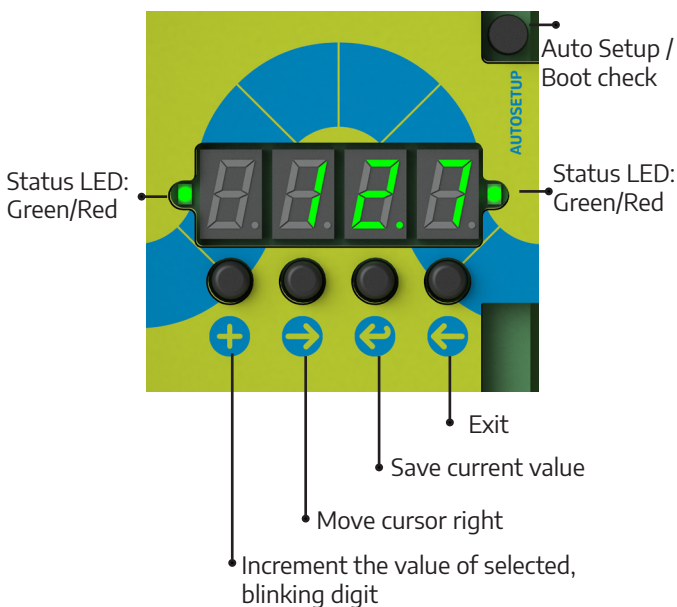

## Return of Investment

This example calculation shows the payback period and cash flow over 3 years based on the loss of product which is caused by a small leakage in the filtration system.

- Gas flow: 100 000 m<sup>3</sup>/h
- Allowable concentration after the filter: 5 mg/m<sup>3</sup>
- Dust concentration after filter damage: 100 mg/m<sup>3</sup>
- Product cost: 0,10 €/kg

### This means:

Lost product: 84 000 kg/year, probably released to the environment.

**More than 20 000 € savings after 3 years.  
And a payback time of less than 3 months.**

### Cash flow over 36 months

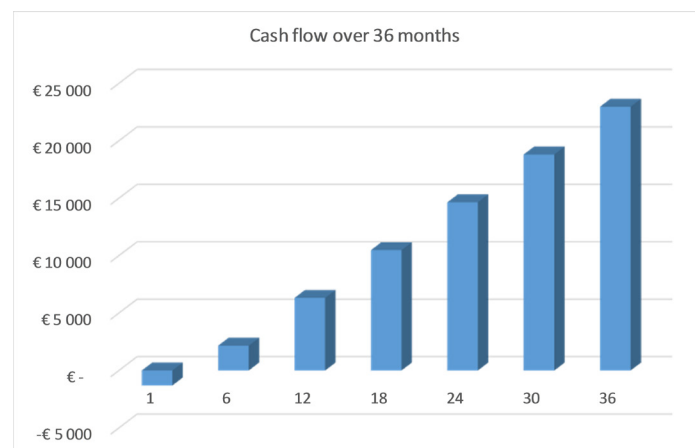

## Industries Served

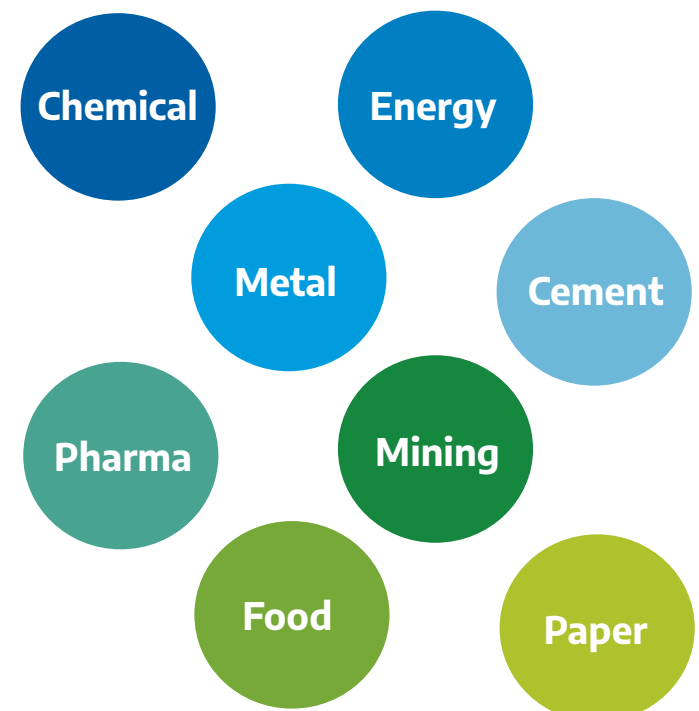

# Common Industrial Applications

## Fabric Filter Monitoring



- Straightforward filter leak detection on an ALERT and ALARM signal base
- Filter performance monitoring and optimization on the mA output signal
- Minimize product loss by sensing even the smallest leaks
- Help identify broken solenoid valves
- Monitor pulse efficiency and help to reduce pulse rates
- Reduce consumption of compressed air
- Enable preventive maintenance
- Proactively reduce emergency downtime

## Monitor Pneumatic Conveying Systems



- Flow / No Flow indication
- Flowrate monitoring with S303 based on a mA output signal
- Receive an early warning over blockages in bulk and powder conveying systems
- Optimize flow rates in conveying systems
- Control fuel feed in boiler applications
- Assure that production is not reduced by a plugged filter

## Extraction and Air Circulation Systems

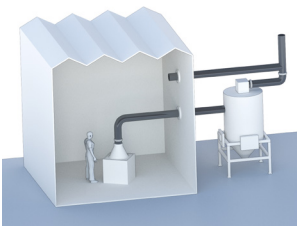

- Help improve clean air working conditions
- Compliance with regulations by monitoring the return air
- According to EN12779 each wood shop which operates an air circulation system bigger than 10 000 m<sup>3</sup>/h needs to be continuously monitored
- Control of the weld fumes removal process
- Immediate alarm in case of filter malfunction

## Measuring in hot conditions such as Steel-, Cement-, Chemical Production or Power Plants

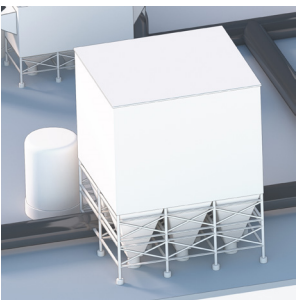

- Detect damage in coke oven walls
- Different probes and coatings allow the measuring of particulate matter in harsh industrial conditions to up to 700 °C
- Teflon coated probes available for conductive and adhesive dust to help on maintenance intervals.
- Diamond coated probes available that can withstand abrasive dust.

## Continuous Particulate Stack Measurements

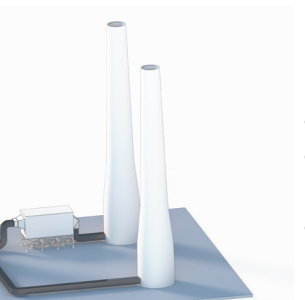

- Emissions monitoring in small and medium sized stacks
- Enables power plants <50 MW to be compliant with the EU directive 2010 / 75 / EU / IED, art 32
- US-EPA, OSHA or other local authorities often require continuous measurements parallel to periodic gravimetric samplings



# Probes and Process Connections

The S300 series comes with a wide range of different probes and process connection options. The new mechanical solutions reflect our field of experience over the last twenty years. Sintrol has engineered and developed the instrument to fit individual processes and demands based on customer needs.

## Standard Probe Including Quick Clamp

The S300 series comes with a 500 mm long probe, made of 316L stainless steel with Ryton as an insulator material. This probe withstands temperatures up to 300 °C and up to 600 kPa pressure. The quick clamp enables fast and easy removal of the instrument. This is beneficial especially in difficult process conditions where the probe might have to be cleaned regularly.



## Probe Lengths and Coatings (Optional)

A wide range of different probes are available as options to allow customized solutions.

Adhesive and wet dusts may create a conductive dust build up on the probe which will negatively influence on the monitor's accuracy and reliability.

As **Inductive Electrification** is based on the transfer of electrostatic load from the probe to the amplifier, conductive dust build up may lead to a bridging effect from the probe to the grounded ductwork. To help avoid this bridging, Sintrol has developed a number of coatings for the different process conditions:

- a) Teflon coating for wet and sticky conditions < 250 °C in non hazardous areas
- b) Diamond coating for abrasive processes
- c) Salokote for wet conditions and abrasive conditions, max length 500 mm



## Air Purge (Optional)

Used in process conditions with high probability of dust build up on the probe. Air purge ensures that the base of the probe stays clean of dust build up.

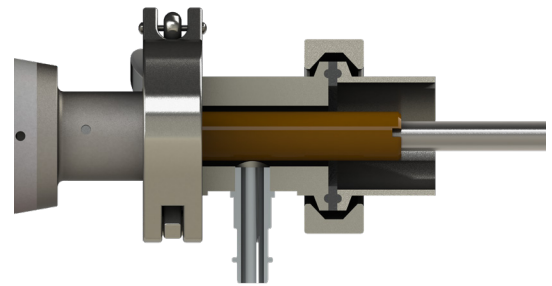

## High Temperature Probe (Optional)

The high temperature probe can be used in process conditions up to 700 °C. The air purge option is not available with this probe. The flanges for the process connection can be chosen to meet customer specifications.

## High Pressure Probe (Optional)

The high pressure probe can be used in process conditions up to 6000 kPa. The air purge option is not available with this probe. The flanges for the process connection can be chosen to meet customer specifications.



## IECEX/ATEX Zone approvals

The certified S303 Ex and S304 Ex models can be used in the following applications:

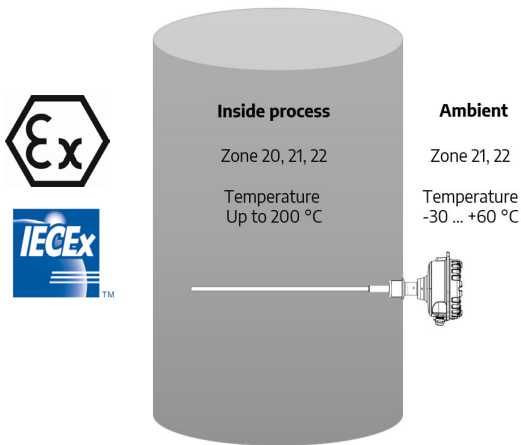

## DustTool Parametrization Software

The S300 series monitors can be managed and parameterized with the **DustTool** PC Software. This offers a convenient platform to view measurement results, to initiate the **Auto Setup** and adjust the parameters of the monitor.

Just connect a USB cable directly to a USB connector or use a generic USB-to-RS485 converter and connect to the device's RS485 bus. **DustTool** will automatically detect the interface being used and connect to the device.

On the parameters page, you can modify the operating parameters of the connected Dust monitor. From the properties view you have full control over software parameters, like network access and password protection.

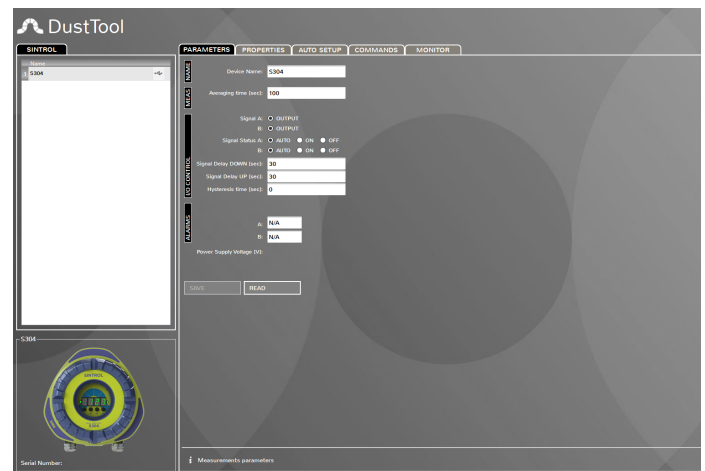

On the monitor view of the DustTool PC software it is possible to follow the dust levels online.

Monitor view is intended to help users when setting up parameters manually.

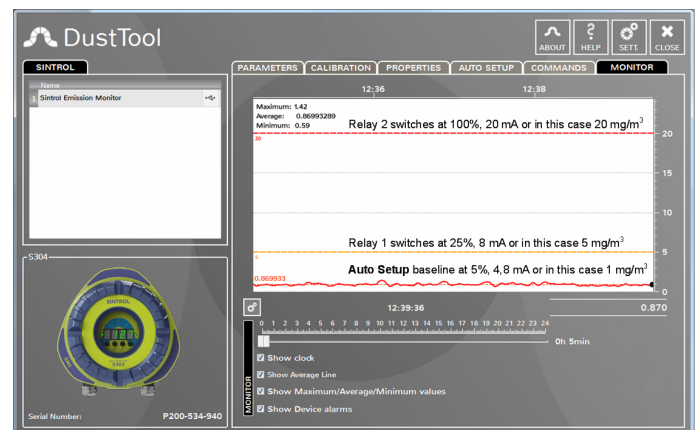

<b>Product Name</b>	<b>S303 PC901022   S303 Ex PC901043   S304 PC901025   S304 Ex PC901046</b>
Measured objects	Total Suspended Particles (TSP)
Measurement principle	Inductive Electrification
Measurement range	Detection Limit 0,01 mg/m <sup>3</sup> Maximum Range up to several g/m <sup>3</sup> , depending on operating conditions
Ingress protection	IP66
Power supply requirements	24 V DC ±10% 1 100 ... 240 V AC ±10%, 50 / 60 Hz
Power consumption	Up to 10 W DC / AC
Output signals	<ul style="list-style-type: none"> <li>2 × Independent SPDT dry contact relays, max. 30 V DC / 5 A or 240 V AC / 5 A, cos φ = 1</li> <li>Isolated active 4 ... 20 mA output loop, max. loop resistance 250 Ω + NAMUR NE 43 compliant alarms</li> </ul>
Communication interface	<ul style="list-style-type: none"> <li>2 × Serial communication RS-485</li> <li>USB</li> <li>Radio frequency (RF, Requires optional RF antenna )</li> </ul>
Communication protocol	<ul style="list-style-type: none"> <li>Modbus RTU (with RS-485)</li> <li>Sintrol network (with USB, RF and RS-485)</li> </ul>
<b>Physical characteristics</b>	
Enclosure	Aluminium
Wetted parts	<ul style="list-style-type: none"> <li>Probe: Stainless steel (316L)</li> <li>Insulation: Polyphenylene sulfide (Ryton R-4)</li> </ul>
Weight	1.5 kg (3.3 lb)
<b>Ambient conditions</b>	
Temperature	-40 ... 60 °C (-40 ... 140 °F) / -30 ... 60 °C for Ex models
Humidity	Max. 95 % relative humidity (non-condensing)
<b>Process conditions</b>	
Temperature	<ul style="list-style-type: none"> <li>Max. 300 °C (572 °F) optionally up to 700 °C (1292 °F)</li> <li>Max. 250 °C (482 °F) with Teflon-coated probe</li> <li>Max 200 °C for Ex models</li> </ul>
Pressure	<ul style="list-style-type: none"> <li>Max. 600 kPa (87.02 psi) in temperatures up to 300 °C (572 °F)</li> <li>Max. 300 kPa (43.51 psi) in temperatures from 300 °C (572 °F) to 700 °C (1292 °F) when high-temperature process connection is used</li> </ul>
Flow velocity	Min. 3 m/s (9.84 ft/s), max. tested 40 m/s (131.23 ft/s)
<b>Wireless communication*</b>	
Frequency bands	<ul style="list-style-type: none"> <li>868 MHz, 15 channels</li> <li>915 MHz (license-free ISM band)</li> </ul>
Transmit power	Up to +23 dBm, user-adjustable
Receiver sensitivity	-110 dBm
Communication protocol	Proprietary Sintrol Network protocol
Typical communication range (non-line of sight)	<ul style="list-style-type: none"> <li>868 MHz version</li> <li>Up to 1000 m (3280 ft) in urban environments**</li> </ul>
Hazardous location approvals	IECEX/ATEX:  II 2 D Ex ia tb IIIC T <sub>200</sub> 93°C ...T201°C Db Ta= -30°C to +60°C US: Zone 20 A Ex ia ta IIIC T85°C...T201°C Da   CAN: Ex ia ta IIIC T85°C...T201°C Da US/CAN: CL II, DV 1, GP E, F, G. IS Probe Ta= -30°C to +60°C

\* Requires optional RF antenna.

\*\* Surrounding structures and other devices using radio frequencies can have significant effect on RF communication range.

# SINTROL GROUP

## OFFICES

SIN303/304Ex02052022

**FINLAND**  
WORLD-  
WIDE

Helsinki  
Tel. +358 9 5617 360  
info@sintrol.com  
www.sintrol.fi  
www.sintrol.com

**UKRAINE**  
Subsidiary

Kiev city  
Tel. +380 442803392  
ua@sintrol.com

**INDIA**  
Representative  
Office

New Delhi  
Tel. +91 9811676061  
india@sintrol.com

**CHINA**  
Representative  
Office

Beijing  
Tel. +86 1 87888681  
china@sintrol.com  
cn.sintrol.com

**JAPAN**  
Representative  
Office

Tokyo  
Tel. +81 90 8585 1301  
japan@sintrol.com

